

FS2100-KC

12" x 12" x 8" DEEP A.R.E. FLOOR SINK WITH ANCHOR FLANGE AND CLAMP COLLAR

LOCATION: _____

Specification & Function

Specification: SUN® FS2100-KC 12" x 12" x 8" deep cast iron body, light duty loose set grate with slotted openings, anchor flange with weep holes, clamp collar, white acid resisting enamel coated interior and top complete with aluminum dome strainer.

Function: Used in kitchens, restaurants, grocery stores, hospitals, schools and other areas that require a large volume sanitary drain.

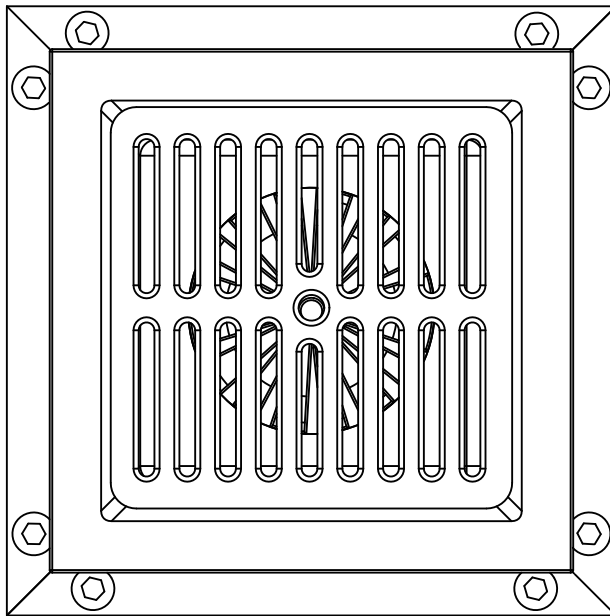

Pipe Size

SUFFIX	DESCRIPTION
<input type="checkbox"/> 2	2" (51) Pipe Size
<input type="checkbox"/> 3	3" (76) Pipe Size
<input type="checkbox"/> 4	4" (102) Pipe Size

Outlet Type

SUFFIX	DESCRIPTION
<input type="checkbox"/> NH	No Hub
<input type="checkbox"/> PO	Push On

Options

SUFFIX	OPTIONAL VARIATIONS
<input type="checkbox"/> -2	Half (1/2) Grate
<input type="checkbox"/> -3	Three-Quarter (3/4) Grate
<input type="checkbox"/> -AB	Sediment Bucket, Aluminum
<input type="checkbox"/> -F4	4" Nickel Bronze Round Funnel
<input type="checkbox"/> -LG	Less Grate
<input type="checkbox"/> -NB	Nickel Bronze Grate
<input type="checkbox"/> -TP	Trap Primer Adapter

Note: Regularly furnished with Enamel full grate unless otherwise specified.

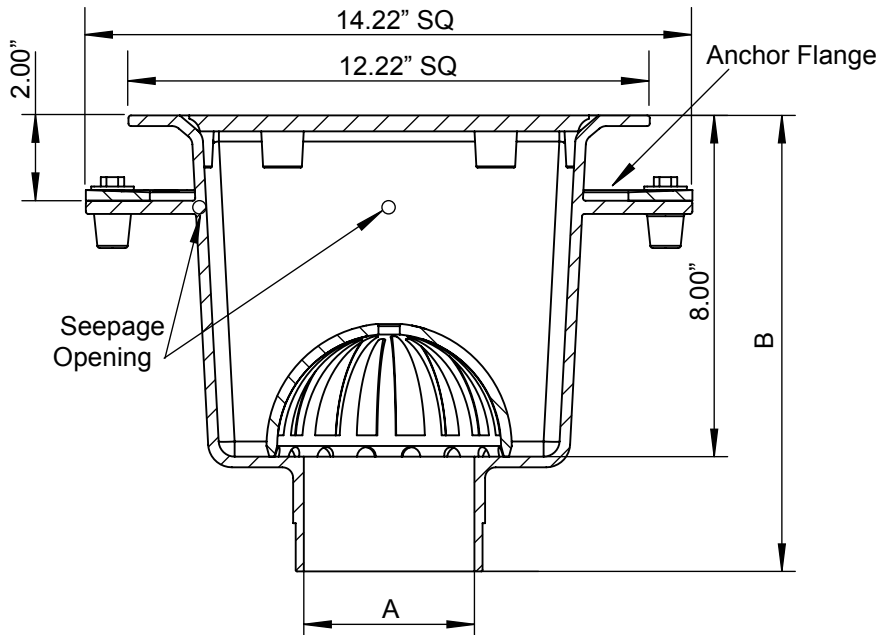

BODY HEIGHT (B)

Pipe Size	No Hub	Push On
2"	10 11/16"	10"
3"	10 11/16"	10"
4"	10 11/16"	10"

***ADD 1/2" TO HEIGHT FOR -NB NICKEL BRONZE FRAME AND GRATE**

PROJECT: _____

CONTRACTOR: _____